

**WE'RE
SERIOUS
ABOUT MAKING
CHAIRS**



PROFILE

We aim to provide high quality designed chairs along with ergonomic standard @ economical range of Director, Executive, Workstation, Training, Conference, Cafeteria & Public Seating System.

We strive to achieve highest level of “CUSTOMER SATISFACTION” Possibility with

Our USP

- ▶ High pressure compressed plywood
- ▶ Branded gas lift (BIFMA Certified)
- ▶ Taiwan’s twin wheel nylon castor (BIFMA Certified)
- ▶ Branded PP Components
- ▶ Moulded PU foams
- ▶ Base with 800kg Load Bearing Capacity, We also provide BIFMA standard base on Request

Highly Experienced Production Team & Expertise Marketing Team with :

Quality Control

Delivery On Time

Quick Resolution

Introducing New Trendy, Sturdy, Comfortable Models.

Kindly go through the ICON’S which indicates warranty period, which vary product to product



No warranty



3 year warranty



1 year warranty



5 year warranty

Based on Icon’s Indication

Things Cover under warranty

1. All Accessories & Components
2. Manufacturing Defects only

Things DO NOT Cover under warranty

1. Chrome Finish
2. PU & Mesh Fabric
3. Transport Damages





GRANDEUR HB



Specification :-

- UPHOLSTERY : ITALIAN HALF LEATHER
- ARMREST : ALUMINUM ARMREST
- GAS SPRING : PASS BIFMA, CLASS-3 TUV 85 MM
- MECHANISM : NON-SYNCHRONIZED MECHANISM WITH ANY POSITION LOCKS
- BASE : 1) 5 STAR ALUMINUM GOLDEN BASE 2) R350MM
- CASTOR : PU CASTOR

Packing Std :
1 Chair 2 Box





CLASSY HB



CLASSY MB



Specification :-

- UPHOLSTERY : ITALIAN HALF LEATHER
- ARMREST : WOOD ARMREST
- MECHANISM : SYNCHRONIZED MECHANISM WITH ANY POSITION LOCK
- GAS SPRING : PASS BIFMA, CLASS-3 TUV 85 MM
- BASE : 1) 5 STAR WOOD BASE 2) R360MM
- CASTOR : PU CASTOR

Packing Std :
1 Chair 2 Box





BOSS HB



BOSS MB



Specification :-

- ⊕ UPHOLSTERY : ITALIAN HALF LEATHER OR PU
- ⊕ ARMREST : ALUMINUM ARMREST
- ⊕ GAS SPRING : PASS BIFMA, CLASS-3 TUV 85 MM
- ⊕ MECHANISM : NON-SYNCHRONIZED MECHANISM WITH 4 POSITION LOCK
- ⊕ BASE : 1) 5 STAR ALUMINUM BASE 2) R350MM
- ⊕ CASTOR : PU CASTOR



BOSS VC



Packing Std :
1 chair 2 Box





GODREZ HB



GODREZ MB



Specification :-

- HIGH BACK WITH JUMBO HEAD REST
- BACK&SEAT FRAME STRUCTURE MADE OF SINGLE PIECE
- UPHOLSTERED WITH MICROFIBER
- ALUMINIUM WITH PU PAD FIXED ARM REST
- TORSHAN BAR SINGLE LOCK TILT MECHANISM
- CLASS 2 120MM HYDRAULIC
- 350MM ALUMINUM BASE
- SUPERIOR NYLON CASTOR



GODREZ VC



Packing Std :
2 chairs 1 Box





DUKE HB



DUKE MB



Specification :-

- HIGH BACK WITH JUMBO HEAD REST
- BACK&SEAT FRAME STRUCTURE MADE OF SINGLE PIECE
- UPHOLSTERED WITH MICROFIBER
- CHROME WITH PU PAD FIXED ARM REST
- TORSHAN BAR SINGLE LOCK TILT MECHANISM
- CLASS 2 120MM HYDRAULIC
- 350MM ALUMINUM BASE
- SUPERIOR NYLON CASTOR



DUKE VC



Packing Std :
2 Chair 1 Box



*Availabe Color Black | Tan



D1 HB



D1 MB



Specification :-

- EXECUTIVE HIGH BACK
- BACK FRAME STRUCTURE MADE OF NYLON
- SEAT & BACK UPHOLSTERED WITH MICROFIBER AND MOULDED CUSHION
- CHROME FIXED ARMREST WITH PU PAD
- MULTI-FUNCTIONAL MACHANISM
- 100MM HYDRAULIC
- 350MM ALUMINUM BASE
- 50MM TWIN SUPERIOR NYLON CASTOR

Packing Std :
1 Chair per Box



D1 VC



Specification :-

- HIGH BACK CHAIR
- BACK & SEAT MADE OF WOODEN UPHOLSTERED WITH PU
- SEAT HIGHT ADJUSTABLE TORSION BAR MECHANISM
- GASLIFT 60MM, BASE WITH NYLON CASTOR



D 001



Specification :-

- HIGH BACK CHAIR
- BACK & SEAT UPHOLSTERED WITH LEATHERATTE
- ALUMINIUM FIXED ARMREST, SEAT HIGHT ADJUSTABLE TORSION BAR MECHANISM
- GASLIFT 85MM, ALUMINIUM BASE WITH NYLON CASTOR



M 38



Packing Std :
1 Chair per Box





REMY HB



REMY MB

Specification :-

- ⊗ EXECUTIVE HIGH BACK
- ⊗ BACK FRAME STRUCTURE MADE OF PA + GF + ALUMINUM
- ⊗ LEATHER + MOLDED FOAM, SLIDING SEAT
- ⊗ 3D ARMREST WITH PU PAD
- ⊗ MULTI-FUNCTIONAL MACHANISM
- ⊗ 100MM HYDRAULIC
- ⊗ ALUMINUM ALLOY FIVE STAR LEG
- ⊗ 50MM TWIN SUPERIOR NYLON CASTOR

Packing Std :
1 Chair per Box



Specification :-

- ⊗ BACK & SEAT STRUCTURE MADE OF PU
- ⊗ FIXED ARMREST WITH PU PAD
- ⊗ CHROME POLISHED LEG



D 004



D 004 BLACK

Packing Std :
4 Chairs per Box





* UPHOLSTERED WITH CUSHION SEAT & BACK

R1-FC



* UPHOLSTERED WITH TAIWAN MESH SEAT & BACK

R1-FM



Specification :-

- ⊗ 4D ADJUSTABLE HEAD REST
- ⊗ BACK FRAME STRUCTURE MADE OF NYLON
- ⊗ UPHOLSTERED WITH TAIWAN MESH BACK
- ⊗ MULTIDIMENSIONAL ADJUSTABLE ARMREST
- ⊗ CUSHION SEAT WITH SLIDER
- ⊗ MULTI ANGLE LOCKING GERMAN MECHANISM
- ⊗ TUV CLASS3 85MM HYDRAULIC
- ⊗ 60MM ALUMINUM BASE , SUPERIOR NYLON CASTOR

Packing Std :
1 Chair per Box





INOX



Function display



Arm pad forward or backward & angle adjustment



adjustable armrest can be adjusted for 7cm



Automatic flexible lumbar support



Multi-function mechanism adjustment
 ① Lean back tilting adjustment
 ② Chair up and down adjustment

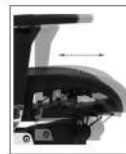

The mesh seat can be adjusted forward and backward within 5cm



Headrest height & angle adjustment, the maximum height of the headrest can be adjusted to 7 cm

Chair Colors



Grey



Black

Packing Std :
 1 Chair per Box





V1



Specification :-

- ⦿ 4 WAY ADJUSTABLE HEAD REST
- ⦿ 5 STAGE HEIGHT ADJUSTABLE BACK FRAME STRUCTURE MADE OF NYLON
- ⦿ UPHOLSTERED WITH PRINTED ELASTIC KOREAN MESH
- ⦿ 4 WAY ADJUSTABLE LUMBER SUPPORT
- ⦿ 3D ADJUSTABLE ARMREST,
- ⦿ MESH SEAT WITH SLIDER
- ⦿ MULTI ANGLE LOCKING ITALIAN MECHANISM
- ⦿ TUV CLASS3 85MM HYDRAULIC
- ⦿ 350MM ALUMINUM BASE
- ⦿ SUPERIOR 60MM NYLON CASTOR

Packing Std :
1 Chair per Box



*Availabe Color Black | GRAY



FILO



Packing Std :
1 Chair per Box



Specification :-

- HIGH BACK EXECUTIVE CHAIR IN MOLDED FOAM
- ADJUSTABLE HEADREST
- 3D ADJUSTABLE ARMREST
- NYLON +24% GLASS FIBER BACK FRAME WITH ADJUSTABLE LUMBAR
- ITALIAN MECHANISM WITH 3 POTION LOCK
- 350 MM ALUMINIUM BASE
- 60MM PU CASTER



*Available Color Black



Q 57



Packing Std :
1 Chair per Box



Specification :-

- ⊕ 360 DEGREE SWIVEL; HEIGHT ADJUSTABLE(UP AND LOW); BACK RECLING&TILT.
- ⊕ MESH BACK + TOP GRAIN PP FIBER BACK FRAME
- ⊕ FLEXIBLE NYLON ARMREST
- ⊕ FABRIC SEAT WITH INJECTION FOAM
- ⊕ ADJUSTABLE FOOREST
- ⊕ SGS CERTIFICATED ELETROPLATING GASLIFT
- ⊕ 180 DEGREE DOUBLE TILT&LOCKING AT ANY POSITION MECHANISM
- ⊕ BASE+60MM PU CASTORS (WHITE COVER)



Specification :-

- MESH BACK + TOP GRAIN PP FIBER BACK FRAME
- HEIGHT ADJUSTABLE HEADREST, UP AND DOWN
- HEIGHT ADJUSTABLE ARMREST WITH SOFT PU ARMPAD, UP AND LOW
- FABRIC SEAT WITH INJECTION FOAM INSIDE
- GASLIFT WITH DOUBLE TILT & LOCKING MECHANISM AT ANY POSITION WITH END PLATE
- 350MM BASE+60MM PU CASTORS(WHITE COVER)



Q 52



Packing Std :
1 Chair per Box



M 21



Specification :-

- HIGH BACK CHAIR
- CHAIR BACK IN BLACK FRAME WITH MESH FABRIC ON BACK AND SEAT
- WEIGHT ACTIVATED SYNCHRONIZ TILTED MECHANISM
- ADJUSTABLE LUMBAR SUPPORT
- PU ARMREST, HEIGHT ADJUSTABLE WITH SWIVEL
- ALUMINUM ALLOY FIVE-STAR BASE ON PA CASTORS

Packing Std :
1 Chair per Box





K 30



K 25



K 18



K 37



K 58

*RECLINER OPTION AVAILABLE

Specification :-

- ④ HIGH BACK CHAIR
- ④ BACK & SEAT UPHOLSTERED WITH PU
- ④ WOODEN FIXED ARMREST, SEAT HIGHT ADJUSTABLE, GASLIFT 85 MM, KICK BACK MECHANISM
- ④ WOODEN BASE WITH NYLON CASTOR

Packing Std :
2 Chair 2 Box





*Available Color Black | Brown



3286 BROWN



3286 BLACK

Ergonomics



The shape of backrest is very fit for human body.



Cushion: 20.1~23.2"



The height of Cushion is adjustable.

Ergonomic design to fit human body

Move



you can move approximate between 0 to 90 degrees.



The handrail is also very soft.

Ergonomic design to fit human body

Rock



90°

110°

you can rock back between 90 to 110 degrees.

pull the lever to rock back till 110°

Ergonomic design to fit human body



Depression design to fit backrest



Soft double cushions

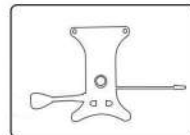

Adjusting the height of cushion

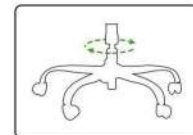

360° swivel action

Packing Std :
1 Chair per Box





*Availabe Color Black | Brown



2216



6121



2683



5301



2798



2687



8024 B



8024 D

Packing Std :
2 Chairs 1 Box



Packing Std :
4 Chairs 1 Box



*Availabe Color Black only



Specification :-

- HIGH BACK CHAIR
- BACK FRAME STRUCTURE MADE OF CHROME
- SEAT & BACK UPHOLSTERED WITH BLACK NYLON MESH
- CHROME FIXED ARMREST
- SINGLE ANGLE LOCKING TORSION BAR TILT MECHANISM
- CLASS 2 100MM HYDRAULIC
- 320MM ALUMINIUM BASE
- 50MM TWIN SUPERIOR NYLON CASTOR



**SLEEK NETTED
HB**



**SLEEK WHITE
REXINE HB**



**SLEEK REXINE
HB**



**SLEEK NETTED
MB**



**SLEEK WHITE
REXINE MB**



**SLEEK REXINE
MB**



**SLEEK NETTED
VC**



**SLEEK WHITE
REXINE VC**



**SLEEK REXINE
VC**

Packing Std :
5 Chairs 2 Box





Packing Std :

Rocky - 2 chairs 1 Box
Wings - 2 chairs 1 Box
Zoho - 4 chairs 1 Box

*Availabe Color Black | White

Specification :-

- BACK FRAME STRUCTURE MADE OF PP
- BACK MESH & SEAT UPHOLSTERED WITH CUSHION
- TILTING MECHANISM & FIXED ARMREST
- BLACK METAL BASE WITH SUPERIOR NYLON CASTOR



*Availabe Color Black | Gray



WINGS MB

- TILT MECHANISM**
WHEN YOU LEAN BACK THE WHOLE CHAIR TILTS.
- ADJUSTABLE ARMRESTS**
FLIP UPWARDS TO FIT UNDER THE DESK WITHOUT BANGING IT
- SEAT HEIGHT ADJUSTMENT**
FIND THE CORRECT AND COMFORTABLE POSITION
- 360° SWIVEL**
FOR MULTI-TASKING CONVENIENCE



RELIEVE TAILBONE PAIN

The coccyx "U" cut-out suspends the tailbone providing the relief you need.



IMPROVE POSTURE

Sit smarter with a cushion designed for healthy posture.



SUPPORT LOWER BACK

Take the pressure of your lower spine to increase comfort.



ZOHO FOLDING CHAIR



STACKABLE EASY CHAIRS





**CORPORATE
VISITOR**



ZD 182 1B

*** BACK FRAME MADE OF POLYPROPYLENE**



1101 C



1181



1182



1113



6009

***Availabe Color
Black | Cream**

Specification :-

- BACK FRAME STRUCTURE MADE OF CHROME
- BACKREST UPHOLSTERED WITH MESH & SEAT WITH CUSHION
- ARMREST CONNECTED TO FRAME MADE OF PP
- CHROME CANTILEVER BASE CONNECTED WITH BACKREST

Packing Std :
5 chairs in 1 Boxes





**CLASSMATE
001**



Specification :-

- ⊗ Black PA back (polyamide, nylon)
- ⊗ 18mm E level medium fiber board writing pad, with water bottle stand 360 degree rotation.
- ⊗ High density foam for seat,
- ⊗ Nylon cup holder
- ⊗ Seat with Taiwan Yida fabric top
- ⊗ Metal frame leg with 4 nylon casters for easy mobility with Book Storage Self.

Packing Std :
1 Chair per Box



Specification :-

- ⊗ Back: Nylon+fiberglass frame+Yida double mesh,tilting back
- ⊗ Seat: Californian fireproof high-density molded form, 12mm plywood, nylon seat bottom shell, can be turn over.
- ⊗ Armrest: Nylon, back&front sliding
- ⊗ Tablet: ABS board with steel plate inside. 360° rotation, 16mm solid steel rotating support
- ⊗ Frame: Folded chair with car brake cables. 1.5 thickness powder painting tube and 1.8mm thickness round cross beam
- ⊗ Nylon fixed foot pad

Packing Std :
2 Chairs per Box



**CLASSMATE
002**



**CLASSMATE
003**

Packing Std :
3 Chairs per Box



Packing Std :
3 Chairs per Box



**CLASSMATE
004**





BIFMA
CERTIFIED













BUTTERFLY HB



BUTTERFLY MB

Packing Std :
2 Chairs per Box



CHAIR SPECIFICATION	 Headrest Adjustment	 Armrest Adjustment	 Lumber Support	 Backrest Tilting	 Locking System	 Tilt Tension Adjustment	 Multi-Limited Tilt Adjustment	 Seat Depth Adjustment	 Seat Height Adjustment	 Base Type
BUTTERFLY HB	●	●	●	●	●	●	—	—	●	CHROME
BUTTERFLY MB	—	●	●	●	●	●	—	—	●	NYLON

● : YES — : NO













OPTIMA HB



OPTIMA MB

Packing Std : 
1 Chair per Box

CHAIR SPECIFICATION	 Headrest Adjustment	 Armrest Adjustment	 Lumber Support	 Backrest Tilting	 Locking System	 Tilt Tension Adjustment	 Multi-Limited Tilt Adjustment	 Seat Depth Adjustment	 Seat Height Adjustment	 Base Type
OPTIMA HB	●	3D	●	●	●	●	●	●	●	OPTIMA CHROME BASE
OPTIMA MB	—	3D	●	●	●	●	●	●	●	OPTIMA CHROME BASE

* BACKREST UPHOLSTERED WITH NYLON MESH

● : YES — : NO



**INDIAN
OPTIMA (A) HB**



**INDIAN
OPTIMA (A) MB**



**INDIAN
OPTIMA (B) HB**



**INDIAN
OPTIMA (B) MB**

Packing Std :
2 Chairs per Box



CHAIR SPECIFICATION	Headrest Adjustment	Armrest Adjustment	Lumber Support	Backrest Tilting	Locking System	Tilt Tension Adjustment	Multi-Limited Tilt Adjustment	Seat Depth Adjustment	Seat Height Adjustment	Base Type
INDIAN OPTIMA (A) HB	●	●	●	●	●	●	●	●	●	OPTIMA CHROME BASE
INDIAN OPTIMA (A) MB	—	●	●	●	●	●	●	●	●	OPTIMA CHROME BASE
INDIAN OPTIMA (B) HB	●	●	●	●	●	●	—	—	●	CHROME
INDIAN OPTIMA (B) MB	—	●	●	●	●	●	—	—	●	CHROME



MAJESTY HB













MAJESTY MB



MYSTIC HB



MYSTIC MB

CHAIR SPECIFICATION	 Headrest Adjustment	 Armrest Adjustment	 Lumber Support	 Backrest Tilting	 Locking System	 Tilt Tension Adjustment	 Multi-Limited Tilt Adjustment	 Seat Depth Adjustment	 Seat Height Adjustment	 Base Type
MAJESTY HB	●	●	●	●	●	●	●	—	●	NYLON
MAJESTY MB	—	●	●	●	●	●	●	—	●	NYLON
MYSTIC HB	●	●	●	●	●	●	●	—	●	NYLON
MYSTIC MB	—	●	●	●	●	●	●	—	●	NYLON



MONARCH HB



MONARCH MB



BREEZE HB



BREEZE MB

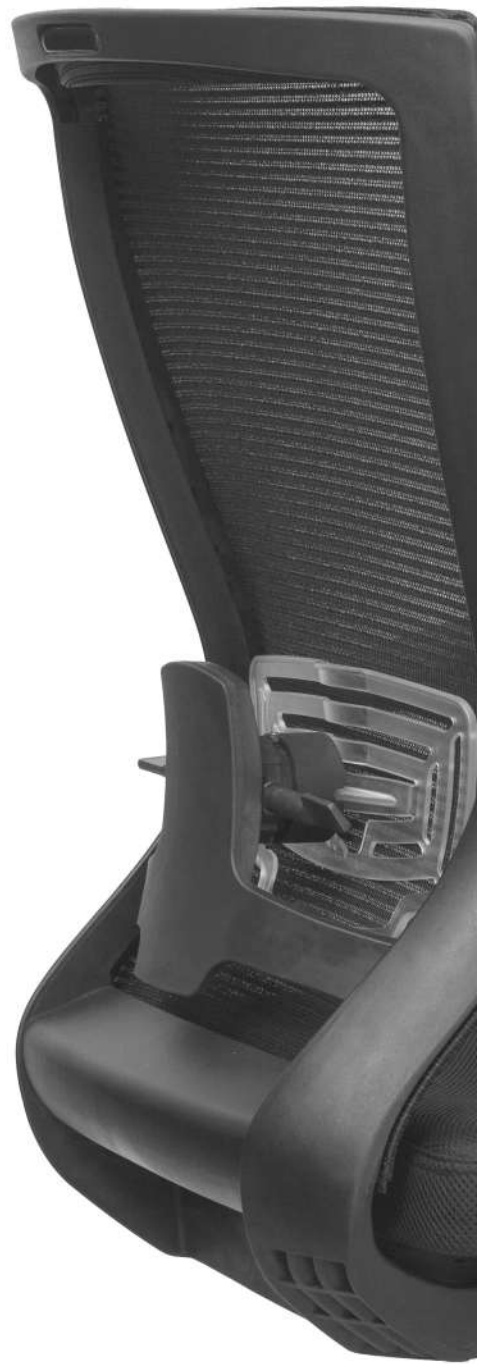

Packing Std :
2 Chairs per Box



CHAIR SPECIFICATION	Headrest Adjustment	Armrest Adjustment	Lumber Support	Backrest Tilting	Locking System	Tilt Tension Adjustment	Multi-Limited Tilt Adjustment	Seat Depth Adjustment	Seat Height Adjustment	Base Type
MONARCH HB	●	●	●	●	●	●	●	—	●	NYLON
MONARCH MB	—	●	●	●	●	●	●	—	●	NYLON
BREEZE HB	●	●	●	●	●	●	●	—	●	NYLON
BREEZE MB	—	●	●	●	●	●	●	—	●	NYLON

● : YES — : NO



BIFMA
CERTIFIED



MATRIX 1 HB



MATRIX 1 MB



MARVEL 1 HB



MARVEL 1 MB

Packing Std :
2 Chair per Box



CHAIR SPECIFICATION	Headrest Adjustment	Armrest Adjustment	Lumber Support	Backrest Tilting	Locking System	Tilt Tension Adjustment	Multi-Limited Tilt Adjustment	Seat Depth Adjustment	Seat Height Adjustment	Base Type
MATRIX 1 HB	●	●	●	●	●	●	—	—	●	CHROME
MATRIX 1 MB	—	●	●	●	●	●	—	—	●	CHROME
MARVEL 1 HB	●	●	●	●	●	●	—	—	●	CHROME
MARVEL 1 MB	—	●	●	●	●	●	—	—	●	CHROME

● : YES — : NO



BONAI HB



BONAI MB

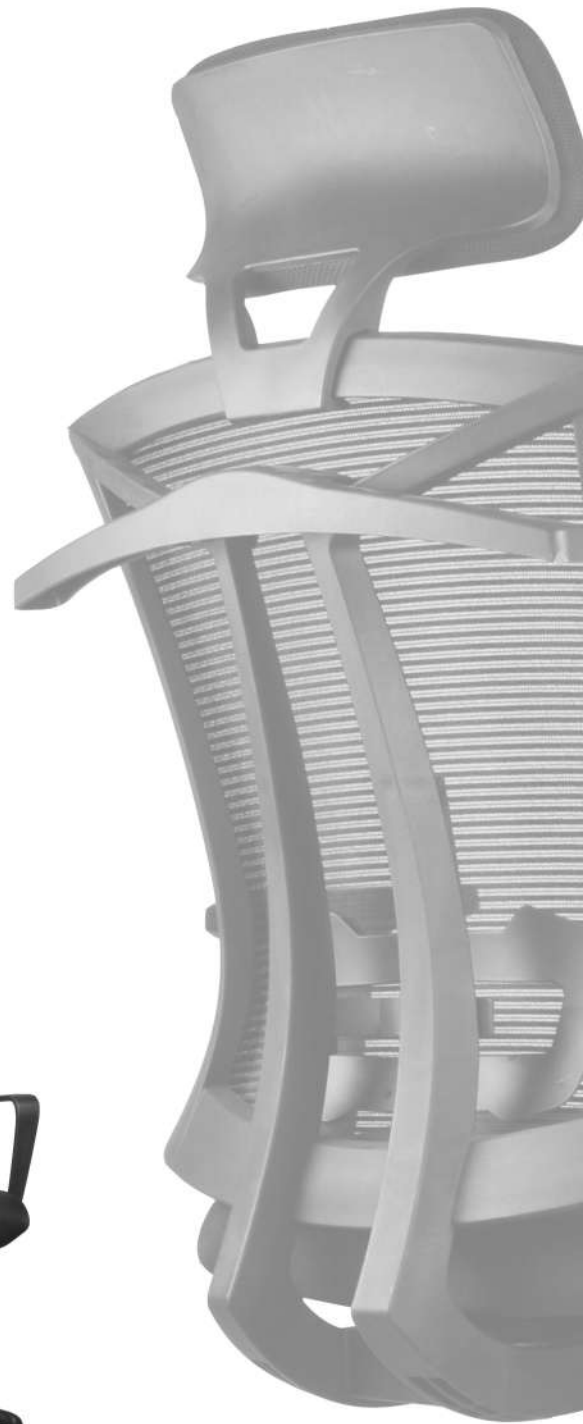











EDGE HB



EDGE MB

Packing Std : 
2 Chairs per Box

CHAIR SPECIFICATION	 Headrest Adjustment	 Armrest Adjustment	 Lumber Support	 Backrest Tilting	 Locking System	 Tilt Tension Adjustment	 Multi-Limited Tilt Adjustment	 Seat Depth Adjustment	 Seat Height Adjustment	 Base Type
BONAI HB	—	●	●	●	●	●	—	—	●	NYLON
BONAI MB	—	●	●	●	●	●	—	—	●	NYLON
EDGE HB	●	—	●	●	●	●	—	—	●	NYLON
EDGE MB	—	—	●	●	●	●	—	—	●	NYLON



MARVEL 2 HB



MARVEL 2 MB



MARVEL 2 VC (FA)



JAZZ HB



JAZZ MB



JAZZ VC (FA)

CHAIR SPECIFICATION	Headrest Adjustment	Armrest Adjustment	Lumber Support	Backrest Tilting	Locking System	Tilt Tension Adjustment	Multi-Limited Tilt Adjustment	Seat Depth Adjustment	Seat Height Adjustment	Base Type
MARVEL 2 HB	●	●	●	●	●	●	—	—	●	NYLON
MARVEL 2 MB	—	●	●	●	●	●	—	—	●	NYLON
MARVEL 2 VC (FA)	—	—	●	—	—	—	—	—	—	METAL FRAME
JAZZ HB	●	●	●	●	●	●	—	—	●	CHROME
JAZZ MB	—	●	●	●	●	●	—	—	●	CHROME
JAZZ VC (FA)	—	—	●	—	—	—	—	—	—	METAL FRAME



GILMA HB



GILMA MB



GILMA VC



NFC HB



NFC MB



NFC VC

CHAIR SPECIFICATION	Headrest Adjustment	Armrest Adjustment	Lumber Support	Backrest Tilting	Locking System	Tilt Tension Adjustment	Multi-Limited Tilt Adjustment	Seat Depth Adjustment	Seat Height Adjustment	Base Type
GILMA HB	—	—	●	●	●	●	—	—	●	CHROME
GILMA MB	—	—	●	●	●	●	—	—	●	CHROME
GILMA VC	—	—	●	—	—	—	—	—	—	METAL FRAME
NFC HB	—	●	—	●	●	●	—	—	●	CHROME
NFC MB	—	●	—	●	●	●	—	—	●	NYLON
NFC VC	—	—	—	—	—	—	—	—	—	METAL FRAME



SENSES HB



SENSES MB



SENSES VC



DOUBLE PLY HB



DOUBLE PLY LB



DOUBLE PLY VC

CHAIR SPECIFICATION	Headrest Adjustment	Armrest Adjustment	Lumber Support	Backrest Tilting	Locking System	Tilt Tension Adjustment	Multi-Limited Tilt Adjustment	Seat Depth Adjustment	Seat Height Adjustment	Base Type
SENSES HB	—	●	—	●	●	●	—	—	●	PP
SENSES MB	—	—	—	●	●	●	—	—	●	PP
SENSES VC	—	—	—	—	—	—	—	—	—	METAL FRAME
DOUBLE PLY HB	—	—	—	●	●	●	—	—	●	PP
DOUBLE PLY LB	—	—	—	●	●	●	—	—	●	PP
DOUBLE PLY VC	—	—	—	—	—	—	—	—	—	METAL FRAME



Easy to Assemble

NO TOOL NO SCREW NO QC NO RISK NO CLAIMS



R7 FOLDING CHAIR



STRIPE MB



CP 188

CHAIR SPECIFICATION	Headrest Adjustment	Armrest Adjustment	Lumber Support	Backrest Tilting	Locking System	Tilt Tension Adjustment	Multi-Limited Tilt Adjustment	Seat Depth Adjustment	Seat Height Adjustment	Base Type
R7 FOLDING CHAIR	—	—	●	—	—	●	●	—	●	PP
STRIPE MB	—	—	—	●	●	●	—	—	●	CHROME
CP 188	—	—	—	—	—	—	—	—	●	PP

● : YES — : NO



INDIGO (A)



INDIGO (B)



COLORS



Packing Std :
1 Chair per Box



CHAIR SPECIFICATION	Headrest Adjustment	Armrest Adjustment	Lumber Support	Backrest Tilting	Locking System	Tilt Tension Adjustment	Multi-Limited Tilt Adjustment	Seat Depth Adjustment	Seat Height Adjustment	Base Type
INDIGO (A)	—	—	—	●	●	●	●	—	●	METAL
INDIGO (B)	—	—	—	●	●	●	●	—	●	METAL

* SEAT & BACKREST UPHOLSTERED WITH PU

● : YES — : NO



BIFMA
CERTIFIED



SOLITAIRE

COLORS



RED



BLUE



ORANGE



MAROON



GREY



GREY WITH BLACK

Packing Std :
2 Chairs per Box



CHAIR SPECIFICATION	Headrest Adjustment	Armrest Adjustment	Lumber Support	Backrest Tilting	Locking System	Tilt Tension Adjustment	Multi-Limited Tilt Adjustment	Seat Depth Adjustment	Seat Height Adjustment	Base Type
SOLITAIRE	—	—	—	●	●	●	—	—	●	PP

● : YES — : NO



BIFMA
CERTIFIED



SPENCER MB



FLASH MB



KAABEL MB



807 MB



XTREAM MESH MB



YUVA MESH MB

CHAIR SPECIFICATION	Headrest Adjustment	Armrest Adjustment	Lumber Support	Backrest Tilting	Locking System	Tilt Tension Adjustment	Multi-Limited Tilt Adjustment	Seat Depth Adjustment	Seat Height Adjustment	Base Type
SPENCER MB	—	●	●	●	●	●	—	—	●	PP
FLASH MB	—	●	●	●	●	●	—	—	●	NYLON
KAABEL MB	—	—	—	●	●	●	—	—	●	NYLON
807 MB	—	●	—	●	●	●	—	—	●	NYLON
XTREAM MESH MB	—	●	—	●	●	●	—	—	●	NYLON
YUVA MESH MB	—	●	●	●	●	●	—	—	●	PP



804 MESH



805 MESH



FLEXI BACK



806 MESH



802 MESH



803 MESH



ACCORD MB



NEW MESH

Packing Std :
2 Chairs per Box



CHAIR SPECIFICATION	Headrest Adjustment	Armrest Adjustment	Lumber Support	Backrest Tilting	Locking System	Tilt Tension Adjustment	Multi-Limited Tilt Adjustment	Seat Depth Adjustment	Seat Height Adjustment	Base Type
804 MESH	—	—	●	●	●	●	—	—	●	PP
805 MESH	—	—	—	●	●	●	—	—	●	PP
FLEXI BACK	—	—	—	●	●	●	—	—	●	PP
806 MESH	—	—	—	●	●	●	—	—	●	CHROME
802 MESH	—	—	—	●	●	●	—	—	●	PP
803 MESH	—	—	—	●	●	●	—	—	●	PP
ACCORD MB	—	●	—	●	●	●	—	—	●	NYLON
NEW MESH	—	—	—	●	●	●	—	—	●	PP



DYNASTY



JUPITER



801 CUSHION



802 CUSHION



803 CUSHION



803 CUSHION VC

CHAIR SPECIFICATION	Headrest Adjustment	Armrest Adjustment	Lumber Support	Backrest Tilting	Locking System	Tilt Tension Adjustment	Multi-Limited Tilt Adjustment	Seat Depth Adjustment	Seat Height Adjustment	Base Type
DYNASTY	—	—	—	●	●	●	—	—	●	PP
JUPITER	—	—	—	●	●	●	—	—	●	PP
801 CUSHION	—	—	—	●	—	●	—	—	●	PP
802 CUSHION	—	—	—	●	●	●	—	—	●	PP
803 CUSHION	—	—	—	●	●	●	—	—	●	PP
803 CUSHION VC	—	—	—	—	—	—	—	—	—	METAL FRAME



805 V



804 V



FLEXI V



KAABEL VC



SOLITAIRE VC



NEW MESH VC

Specification :-

- Backrest Frame structure made of PP upholstered with mesh & Cushion Seat
- PP Fixed Armrest
- 1 inch Dia MS pipe Base

Packing Std :
2 Chairs per Box





CUP WHITE



CUP BLACK

Specification :-

- Backrest Frame structure made of PP upholstered with mesh & Cushion Seat
- PP Fixed Armrest, Tilting Mechanism with Class 2 100mm Gaslift
- Chrome Base with Nylon Castor

LEVEL UP CHAIRS



**BARSTOOL
CUP WHITE**



**BARSTOOL
CUP BLACK**



**BARSTOOL
803 MESH**



**BARSTOOL
803 CUSHION**

Specification :-

- Backrest Frame structure made of PP upholstered with mesh & Cushion Seat
- PP Fixed Armrest, Cup Mechanism with 260mm Gaslift
- Nylon Base with wheel bush



MARVEL SHELL



AXIS SHELL

Specification :-

- BACK&SEAT FRAME STRUCTURE MADE OF SINGLE PIECE
- Plastic Legs



**CURVE
BARSTOOL**



**BARSTOOL
MESH MAROON**



**BARSTOOL MESH
BLACK & WHITE**

* COLORS AVAILABLE

- BLUE
- BLACK
- GREEN
- ORANGE
- WHITE

Specification :-

- Back Frame structure made of Chrome upholstered with Breathable Mesh Back & Seat
- High Adjustable Mechanism with 260mm Gaslift with Foot Ring
- 380mm Chrome Base Plate





Colors



VISITOR MESH



GAAMA WC S&B



MEGHNA SHELL



GAAMA



GAAMA WFW PAD WC



GAAMA WHW PAD

Packing Std :
1 chair per box



* Available Colors May Vary From Pic

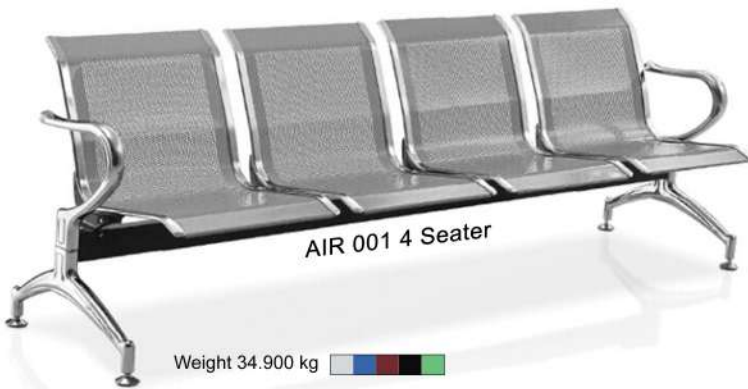



METRO SOFA 1 SEATER



METRO SOFA 2 SEATER



METRO SOFA 3 SEATER



METRO SOFA 4 SEATER



METRO SOFA 5 SEATER



METRO SOFA 3 SEATER HB



METRO SOFA 3 SEATER 4 Arms
* CENTRE ARM AVAILABLE IN 1-5 SEATER

* High Back Seating System Also Available | Cushion Seats Also Available in all 1 - 5 Seaters

Specification :-

- * **Seat & Back**
Processed with 1.2mm thickness cold rolled MS sheet and furnished with powder coating.
- * **Armrest**
Processed with 1.6mm MS tube and furnished with powder coating.
- * **Leg**
Processed with 1.0mm thickness ms sheet and furnished with powder coating.
- * **Center support beam**
Processed with 2mm thickness MS seat and also furnished with powder coating.

SEATS	PRODUCT	WEIGHT
1	M.B	17.234
2	M.B	27.532
3	M.B	37.92
4	M.B	48.852
5	M.B	59.147
3	M.B 4 ARMS	40.62

Note : The Above Weight is Included Packing

MAKE IN INDIA

METRO sofa

Curvy Ergonomical Design



SEATER SIZE

Available in 1 | 2 | 3 | 4 | 5 Seater

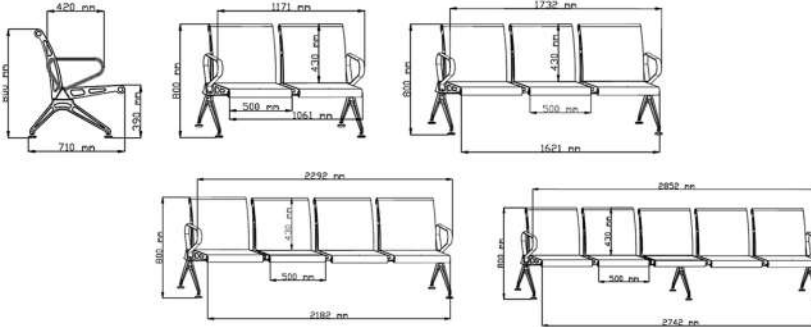

COLOR OPTIONS

Midnight Black | Sparkling Silver | Wine Red | Emerald Green | Azure Blue

CUSHION OPTIONS

Half Cushion only available



